



THE OFFICIAL

**RULES/REGULATIONS
GUIDELINES
SPECIFICATIONS**



FOR THE SPORT OF
HORSESHOE PITCHING

Adopted July 16, 2006
Revised January 1, 2024

TABLE OF CONTENTS

I. PLAYING RULES

RULE 1 - PITCHING DIVISIONS	7
Section A - Juniors	7
Section B - Cadets	8
Section C - Open Men	8
Section D - Open Women	8
Section E - Seniors	8
Section F - Elder Men	8
RULE 2 - GAME PREPARATION	9
Section A - Court Assignment	9
Section B - Pit Preparation and Maintenance	9
Section C - Painting of Stakes	9
Section D - Start of Each Tournament/Class	9
Section E - Court Rotation	10
RULE 3 - PLAY OF THE GAME AND VALUE	
OF THE SHOE	10
Section A - Innings	10
Section B - Value of the Shoe	10
Section C - Delivery of Shoes	10
Section D - Position of Contestants During Delivery	11
Section E - Crossing Over	11
RULE 4 - FLOW OF THE GAME	12
Section A - Possible Delays	12
RULE 5 - FOUL SHOES	13
Section A - Removal from Pit	13
Section B - Enforcing Violations	13
RULE 6 - SCORING THE GAME, CALLING THE SCORE	14
Section A - Methods of Scoring	14
Section B - Calling the Score	15
Section C - Recording the Score	15
RULE 7 - PITCHING ROTATION DURING THE GAME	16
Section A - Cancellation Rotation	16
Section B - Count-All Rotation	16
Section C - Handicap Rotation	16
Section D - Pacer Rotation	16

Section E - Pitching Out of Turn	16
RULE 8 - LENGTH OF GAMES, BREAKING OF TIE GAMES	16
Section A - Length of Games.	16
Section B - Breaking of Tie Games	17
RULE 9 - BROKEN OR CRACKED SHOES.	17
Section A - Broken Shoes	17
Section B - Cracked Shoes	17
RULE 10 - LOOSE OR BROKEN STAKES	17
Section A - Loose Stakes.	17
Section B - Broken Stakes.	17
RULE 11 - TOURNAMENT/LEAGUE PLAY	18
Section A - Standard Method of Sanctioned Tournament Play	18
Section B - Determining Class Winners, Breaking of Class Ties.	18
Section C - Ringer Percentage	19
Section D - Seeding Contestants.	19
Section E - Mixed Classes.	20
Section F - Handicapping.	20
Section G - Forfeits	20
RULE 12 - APPROPRIATE NHPA MEMBER CONDUCT	20
Section A - On the Courts	20
Section B - Sportsmanship.	21
Section C - Dress Code	21
Section D - Alcohol, Tobacco Products, and Illegal Controlled Substances.	21
Section E - Cell Phones.	21
Section F - Protests	21
II. REQUIREMENTS	22
REQUIREMENT 1 - TOURNAMENT/ LEAGUE OFFICIALS	22
Section A - Duties and Responsibilities.	22
REQUIREMENT 2 - ALL NHPA TOURNAMENTS/LEAGUES	23
Section A - Sanctioning	23
Section B - Eligibility	23
Section C - Fees	23
Section D - Division Size	23

Section E - Tournament Credit	24
Section F - League Credit	24
Section G - Count-All Scoring	24
Section H - Total Ringers/Shoes	24
Section I - Reporting Results	24
REQUIREMENT 3 - CHARTER/STATE INFORMATION	24
Section A - Championship Play	24
Section B - Newslines	25
Section C - Delegates	25
Section D - Compliance	26
REQUIREMENT 4 - WORLD TOURNAMENT PLAY	26
Section A - Committee and Director	26
Section B - Divisions	25
Section C - Championship Finals	26
Section D - World Title	26
Section E - Division Winners	26
Section F - Playoffs	26
Section G - Records	27
Section H - Eligibility	27
Section I - Awards	27
REQUIREMENT 5 - FOR SPECIAL TOURNAMENTS OR EVENTS	28
Section A - Events	28
Section B - Waiver	28
REQUIREMENT 6 - CADET AND JUNIOR PITCHERS - Additional Information	28
Section A - Adult Divisions	28
Section B - Eligibility	28
Section C - Awards	28
Section D - Responsibility	28
III. GUIDELINES	29
GUIDELINE 1 - DOUBLES PLAY	29
Section A - Regular Doubles	29
Section B - Walking Doubles	29
GUIDELINE 2 - CALLING THE SCORE	30
Section A - Recommended Calls	30
Section B - Alternative Calls	30

Section C - Recommended Hand Signals	31
GUIDELINE 3 - KEEPING SCORE	33
Section A - Before the Game	33
Section B - During the Game	33
Section C - After the Game	34
Section D - Scoreboards	34
Section E - Electronic Scoring Device	34
Section F - Hand Signals	34
GUIDELINE 4 - JUDGING	34
Section A - Responsibilities, Expectations and Duties	34
GUIDELINE 5 - PACERS	35
Section A - Use of Pacers	35
Section B - Qualified Pacers	35
Section C - Awards and Statistics	35
GUIDELINE 6 - UNSPORTSMANLIKE BEHAVIOR	35

IV. SPECIFICATIONS

I - EQUIPMENT SPECIFICATIONS	36
Section A - Sanctioned Horseshoes	36
Section B - Altered Horseshoes	37
Section C - Legal Horseshoe Repair	37
Section D - Horseshoes Sanctioned in Other Countries	37
Section E - Pitching Accessories	37
II - SPECIFICATIONS FOR	
COURT LAYOUT	38
Section A - Sanctioning of Courts	38
Section B - Court Sanction Requirements/ Specifications	39
Section C - Specifications for Raised Pits	42
Section D - Specifications for Covered and Indoor Courts	42

GLOSSARY

Altered Shoe	43
Alternate Pitch	43
Backstops/Backboards	43
Broken Shoe	43
Burr	43
Bylaws	43

Caliper	43
Cancellation Scoring	43
Class	43
Class Winners	43
Count-all Scoring	43
Cracked Shoe	44
Crossover Areas	44
Dead Shoe	44
Division	44
Doubles Play	44
Dress Code	44
eShoes	44
Extended Platforms	44
Feeler Gauge	44
Foul	44
Foul Shoe	44
Guidelines	44
Handicap	44
Handicapping	44
Heel or Heel Calk	45
Hooks	45
Imaginary Stakes	45
Inning	45
Judges	45
Leaner	45
Legal Shoe	45
Live Shoe	45
Medical Exemption	45
Mixed Classes	45
National Membership	45
Newsline	45
NHPA	45
NHPF	46
Pacer	46
Pit	46
Pit Substance	46
Pitcher's Box	46
Pitching Platforms	46
Pitching Rotation	46
Point Limit Game	46
Point Limit or Shoe Limit Game	46
Portable Pits	46

Protest	46
Requirements	46
Ringer.	46
Ringer Percentage	47
“Ringers Only” Scoring.	47
Round.	47
Round Robin Play	47
Rules of Play	47
Sanctioned Club/League Program.	47
Sanctioned Court	47
Sanctioned Event.	47
Sanctioned Tournament.	47
Scorekeeping	47
Scoring Area.	47
Scoring Radius.	47
Scratch Play	48
Seeding	48
Shoe in Count	48
Shoe Limit Game	48
Shoe Out of Count	48
Single Point	48
Specifications	48
Sportsman-like Conduct.	48
Stakes	48
Straightedge.	48
Temporary or Raised Court	48
Time Limit.	48
Toe.	48
Welded Shoe	48



THE OFFICIAL NHPA PLAYING RULES, REQUIREMENTS, GUIDELINES, AND SPECIFICATIONS FOR THE SPORT OF HORSESHOE PITCHING (aka The RGS Book)

Published by
The National Horseshoe Pitchers Association
(NHPA)
(Revised on January 1, 2021)

I. PLAYING RULES

This section explains the playing rules of horseshoes and may specify a general or specific penalty for violations. These rules apply for all NHPA-sanctioned events, which includes tournament play and/or league play. All contestants, including pacers and/or league substitutes, must be current NHPA members (see Bylaws for additional information). Failure of contestants to abide by these rules may result in penalties that range from a verbal reminder, loss of points, forfeiture of games, or suspension of membership. Failure of the Tournament/League Officials (or designees) to monitor and enforce these rules could result in penalties to the club or Charter. This same information can also be found on the NHPA website at www.horseshoepitching.com and is recommended for anyone playing the game for recreation or non-sanctioned play.

RULE 1 - PITCHING DIVISIONS

Section A - Juniors (See REQUIREMENT 6, for exceptions and additional information)

1. **Junior Boys** (any male pitcher eighteen (18) years old or younger for the entire calendar year)

Junior Boys may pitch from any place on the extended or full-distance platforms. They shall observe the twenty-seven-foot (27') foul lines. **Note:** Junior Boys may choose to move into the Open Men Division prior to the age guidelines, but cannot return to the Junior Boys, once this declaration has been made.

2. **Junior Girls** (any female pitcher eighteen (18) years old or younger for the entire calendar year)

Junior Girls may pitch from any place on the extended or full-distance platforms. They shall observe the twenty-seven-foot (27') foul lines. **Note:** Junior Girls may choose

to move into the Open Women Division prior to the age guidelines, but cannot return to the Junior Girls, once this declaration has been made.

Section B - Cadets(See REQUIREMENT 6, for exceptions and additional information)

1. **Cadet Boys** (any male pitcher twelve (12) years old or younger for the entire calendar year)

Cadet Boys may pitch from any place on the extended or full-distance platforms. They shall observe the twenty-foot (20') foul lines. **Note:** Cadet Boys may choose to move into the Junior Boys Division prior to the age guidelines, but cannot return to the Cadet Boys, once this declaration has been made.

1. **Cadet Girls** (any female pitcher twelve (12) years old or younger for the entire calendar year)

Cadet Girls may pitch from any place on the extended or full-distance platforms. They shall observe the twenty-foot (20') foul lines. **Note:** Cadet Girls may choose to move into the Junior Girls Division prior to the age guidelines, but cannot return to the Cadet Girls, once this declaration has been made.

Section C - Open Men (no age restriction)

Open Men contestants shall pitch from on or behind the full-distance platforms and shall observe the thirty-seven-foot (37') foul line.

Section D - Open Women (no age restriction)

Open Women contestants may pitch from any place on the extended or full-distance platforms and shall observe the twenty-seven-foot (27') foul line.

Section E - Seniors (become eligible to pitch in the Senior Division at any time during the calendar year that they become sixty (60) years old) **Note:** Seniors may choose to remain in the Open Men or Open Women Divisions.

1. **Senior Men** shall pitch from on or behind the full-distance platforms and shall observe the thirty-seven-foot (37') foul line.
2. **Senior Women** may pitch from any place on the extended or full-distance platforms and shall observe the twenty-seven-foot (27') foul line.

Section F - Elder Men (become eligible to pitch in the Elders Division upon purchase of an NHPA card dated for the calendar year that they become sixty-five (65) years old).

1. **Elder Men** may pitch from any place on either the extended or full-distance platforms, and shall observe the twenty-seven-foot (27') foul line. Elder Men must notify their Charter Membership Director, in advance, of the date that they intend to begin pitching from this shorter distance. Once a member declares himself a short-distance pitcher, he must remain in that Division until the next

year's membership card is purchased. At that time he may switch back to the Open Men's division, but must remain in that division until the next year's membership card is purchased. **Note:** See Rule 11, Section D.1 for additional information about re-qualifying.

2. Physically Challenged Men - Physically challenged, Male pitchers less than sixty-five (65) years old may be given permission, by their governing Charter, to move onto the extended platforms in the Elders Division and observe the twenty-seven-foot (27') foul lines. The prior completion and approval of a Medical Exemption Application form (available from Charter Secretaries and on some Charter Websites) is required. At the World Tournament and at State Championship Tournaments, they shall compete in the Elders Division.

RULE 2 - GAME PREPARATION

Section A - Court Assignment

Each contestant shall find his or her court assignment and warm up on that court for their first game. The court shall be prepared for play in a timely manner so that all games can begin at about the same time.

Section B - Pit Preparation and Maintenance

Contestants (or designee) are responsible for preparing one of the pits of their assigned courts before each game. This preparation includes watering and turning of the clay (if needed), to keep it in a soft, putty-like condition. Upon completion, the pit material shall be level with the pitching platforms, with no evidence of a "dome" or "pocket" within the scoring area. For raised pits, the pit material should be prepared in the same way as above, except that the pit material shall be level with the side rails, and at a depth of four inches (4"), within the scoring area. Once a game has started, clay pit material within the scoring area may not be moved or altered without consent of the opponent. Sand or dirt pit material, however, may be re-leveled during the game, without consent of the opponent. Any pit material moved for the measurement of a shoe or for the removal of a "buried" shoe may be replaced.

Section C - Painting of Stakes

To make the stakes more visible for the contestants, they may be painted between games (white paint is often used) so that there is a good contrast between the color of the stake and the color of the backboard. The painting of stakes shall not be allowed while a game is in progress, unless both contestants are in agreement.

Section D - Start of Each Tournament/Class

The tournament officials will make an announcement when it is time for the tournament/class to begin. The first game should not begin before this announcement. The flip of a shoe(s) or coin(s) shall signify the beginning of each game. The winner of the flip will have choice of first or second pitch.

Section E - Court Rotation

At the World Tournament, following the end of each game, contestants can practice on their current court until all games of that round are completed. At that time contestants shall move to their next assigned court and may practice until their next opponent arrives. Then both pits shall be prepared for play (see Section B above). When the scorekeeper is ready, the contestants have the option of pitching no more than four (4) additional warm-up shoes each, and then the next game must begin immediately.

Note: Contestants who may choose to start the game (non-World Tournament) of their next round, before all games of the current round have been completed, must realize that their game may be interrupted by distractions such as pit preparation and/or other nearby movements.

RULE 3 - PLAY OF THE GAME AND VALUE OF THE SHOE

Section A - Innings

The game is divided into innings. Each inning consists of four (4) pitched shoes; two (2) by each contestant.

Section B - Value of the Shoe

1. Pitched shoes - After all shoes for the inning have been pitched, they are either considered to be “live shoes” or “dead shoes” and may then be scored accordingly.

(a) Live Shoe - Refers to any shoe that has been pitched in compliance with the rules of the game and that comes to rest within the pit area.

(b) Dead Shoe - Another term for a foul shoe that was delivered in non-compliance with one of the rules of the game. This term may also refer to a ringer that has been “cancelled” by an opponent’s ringer.

2. Shoe in Count

(a) Ringers - A ringer is a *live* shoe that comes to rest while encircling the stake. A straightedge touching either the points or any part of the heel calks (see diagram on page 48) of the shoe must clear (not touch) the stake in order for it to be declared a ringer. A ringer has a value of three (3) points. (See exception for “Ringers Only” format – Rule 6, Section A.2)

(b) Points - A *live* shoe that is not a ringer, but comes to rest six inches (6”) or closer to the stake, has a value of one (1) point. This includes a “leaner”.

3. Shoe out of Count - A shoe that comes to rest more than six inches (6”) from the stake is a shoe “out of count” and has no scoring value. A foul shoe (see Rule 5 for additional information) is also considered to be a shoe that is out of count, no matter where it comes to rest.

Section C - Delivery of Shoes

1. Delivery - The contestant pitching first shall deliver both shoes (underhanded, and one at a time) and then the other

contestant shall deliver both shoes (underhanded, and one at a time). A contestant may deliver the shoes from either the left or right pitching platform, but in any one inning, both shoes must be delivered from the same platform. A contestant shall pitch the entire tournament with the same hand/arm, except in the case of a medical emergency (to be determined by the Tournament/League Officials).

- 2. The Pitcher** - During the entire address and prior to the release of the shoe, the contestant must not start or step completely outside the pitching platform with either foot.

Exceptions:

(a) A contestant observing the thirty-seven-foot (37') foul line may start directly behind the pitching platform provided they step within it when they release the shoe.

(b) A physically challenged contestant requiring assistance of special equipment, such as a wheelchair, must have at least some contact with the pitching platform and be completely behind the twenty-seven-foot (27') foul line when the shoe is released.

- 3. Time Limit** - A contestant shall deliver both shoes within thirty (30) seconds. This time limitation shall be determined by a judge and will start when the contestant steps onto the pitching platform with the intention of pitching and is in a "set" position for the first pitch.

Exceptions:

(a) Extra time will be allowed to repair a damaged shoe (filing a burr for example).

(b) If a contestant becomes distracted due to unusual playing conditions or by another contestant or spectator, they will not be penalized for this additional time.

- 4. Accidental Release** - Any shoe that leaves a contestant's hand once the final step (if taken) and final forward swing of the delivery process has started, shall count as a pitched shoe. A shoe that is accidentally dropped by a contestant before the final step (if taken) and final forward swing has started, shall not be considered a foul shoe and may be picked up and pitched.

Section D - Position of Contestants During Delivery

When not pitching, any contestant shall stand quietly and stationary, at least two (2) feet behind their opponent, on their court's opposite pitching platform, or behind any pitcher on an adjacent platform.

Section E - Crossing Over

If both contestants use the same pitching platform to deliver their shoes, the contestant pitching first should cross over (in front of the pit) to the other pitching platform and then move back to the position described in Section D, above. As the first contestant is crossing over in front, the second contestant should be crossing over and onto the same pitching platform, from the rear. If the contestants use opposite pitching platforms, the contestant

who pitches first should step directly back, to the position described in Section D, above.

RULE 4 - FLOW OF THE GAME

Section A - Possible Delays

- 1. Scoring** - Once the four (4) shoes of an inning have been pitched, the contestants shall walk to the opposite pit, determine the score for the inning, and then retrieve their shoes. No shoe shall be moved before its' scoring value is determined. If this decision is in doubt, a judge shall be called. The judge shall make the necessary measurements and determine the scoring for the shoe(s) in question. To help speed up play, contestants are encouraged to carry measuring tools and to make their own decisions on scoring, whenever possible. Play shall continue in a similar fashion for each inning until the game is completed.
- 2. Opposite Stake** - No contestant shall walk to the opposite stake (except to remove a foul shoe) or ask to be informed about the position of any pitched shoes prior to the completion of an inning.
- 3. Spare Shoes** - At any one time, a contestant shall carry and use only two (2) sanctioned horseshoes during the course of a game. A spare shoe or shoes should be taken along to the courts in case of a broken shoe or if the contestant chooses to switch shoes. Shoes may be switched between innings, but not during an inning, unless a shoe breaks.
- 4. Wrong Shoe** - If it is discovered during an inning that a contestant has pitched the shoe of an opponent (and if the opponent agrees), the remaining shoes may be pitched and the score will be based on the shoes they pitched. If the contestants do not agree on pitching the remaining shoes, then the shoes pitched shall be picked up and the entire inning shall be re-pitched, using the correct shoes. If the contestants fail to discover this error until after all four (4) shoes have been pitched, the inning shall be scored on the basis of whatever shoes they pitched. If agreement cannot be reached, a judge shall be called. Based upon input from the contestants, the judge shall either determine the scoring for the inning or void it and order the inning to be re-pitched.
- 5. Moving The Shoe Or Stake** - When a *contestant* is measuring a shoe and the shoe (or the stake) is accidentally moved, the inning shall be scored only if the contestants can come to an agreement. If no agreement can be reached, a judge shall be called. The judge shall either determine the scoring or void the inning and order it to be re-pitched. When a *judge* is measuring a shoe and the shoe (or the stake) is accidentally moved, the judge shall either determine the scoring for the inning or void it and order it to be re-pitched.

Exceptions: Any shoes for which point values have been agreed upon by the contestants (such as ringers which may have been removed to measure other shoes) should

not be re-pitched or have their value changed due to a re-pitch of other shoes. Only the shoe(s) in question when the shoe or stake was moved should be ordered re-pitched by the judge. If one or more shoes are below the shoe(s) in question, they shall remain in place for the re-pitch and shall be scored at the completion of the inning.

- 6. Leaving The Courts** - If a contestant has to leave the area of the court complex between games for a legitimate reason, they shall notify their next opponent, the scorekeeper, or a Tournament/League Official and shall return soon after the last game of that round is completed. Failure to return in a reasonable period of time (to be determined by the Tournament/League Officials) will result in the forfeiture of that *next* game.

RULE 5 - FOUL SHOES

Section A - Removal from Pit

A *foul shoe* is a shoe that is delivered in non-compliance with one of the rules listed below. It scores as a shoe "out of count" (see RULE 3, Section B.3) and is to be removed from the pit (if it appears to be within the scoring area of the stake) before any more shoes are pitched. **Note:** *Live* shoes already in the pit area that may be disturbed by a foul shoe (or other live shoes), are not to be removed, unless they are knocked into foul territory and then come to rest in the scoring area. Live shoes shall be scored "as they lie", after all shoes for the inning have been pitched.

Section B - Enforcing Violations

1. Enforced by Judge

The following are rules violations that must be spotted and called by an assigned judge. The penalty is to declare the shoe a foul shoe.

- (a) Any shoe pitched when the contestant, during the delivery, has stepped on or over the foul line before releasing the shoe.
- (b) Any shoe pitched when the contestant has started or stepped completely outside the pitching platform with either foot before releasing the shoe (see exceptions in RULE 3, Section D-1a, 1b).
- (c) Any shoe not delivered within the thirty (30) second time limit (see RULE 3, Section C-2).

2. Monitored by Judge and Contestants

The following occurrences are also considered foul shoes and, where it applies, the shoes must be removed from the pit (if they appear to be in the scoring area of the stake) before any more shoes are delivered, unless all contestants in that game agree to leave a foul shoe where it is.

- (a) Any shoe pitched with the opposite hand/arm; in the same tournament (See also RULE 3, Section C.I).

- (b) The second shoe, if it is pitched from a different platform than the first shoe.
- (c) Any shoe that contacts the backboard, platform, court frame, or any ground outside the pit area before it comes to rest.
- (d) Any shoe that strikes a permanent object such as a tree limb, wire, indoor court ceiling, etc. **Note:** A shoe that strikes a foreign, moving object is not foul and may be re-pitched.
- (e) The second shoe if the contestant changes shoes after the first shoe has been pitched. The only exception is if the first shoe has broken and qualifies for a re-pitch.
- (f) A contestant's shoe(s), if the contestant removes any shoe before the scoring of that shoe has been agreed upon. If the contestants cannot agree, a judge shall be called to determine the scoring or may order the inning re-pitched.

RULE 6 - SCORING THE GAME, CALLING THE SCORE

Section A - Methods of Scoring

There are *two methods* of scoring the game of horseshoes: *cancellation scoring* and *count-all scoring*. The method of scoring to be used shall be announced by the Tournament/League Officials before the tournament begins. **Note:** Shoes that land outside of the "in count" area or that are declared foul shoes (see RULE 5) shall score zero (0) points.

- 1. Cancellation Scoring** - In cancellation scoring, the ringer(s) of one contestant *cancel* the ringer(s) of the opponent. Cancelled ringers are also referred to as "dead" ringers. **Note:** only *one* contestant can score in each inning.
 - (a) **Ringer Point Values** - Any cancelled ringer scores zero (0) points. Any un-cancelled (live) ringer scores three (3) points.
 - (b) **Shoes In Count** - A shoe six (6") inches or closer to the stake is "in count" and shall score one (1) point under the following conditions:
 1. If there are two (2) cancelled (dead) ringers and no live ringer, the closest shoe to the stake, which is in count, shall score one (1) point.
 2. If there are no ringers, the closest shoe in count shall score one (1) point. If the other shoe of the same contestant is the second closest shoe in count, it shall score one (1) additional point.
 3. If there is one un-cancelled (live) ringer and if the other shoe, of the scoring contestant, is the closest in-count shoe to the stake, it shall score one (1) point (a total of four (4) points).
 4. Opposing contestant's shoes that are touching the stake, or that are in count and determined to be an equal distance from the stake, shall cancel each

other and, like cancelled ringers, shall score zero (0) points. In this situation, the next closest shoe in count (if there is one) shall score one (1) point.

2. Count-all Scoring - In count-all scoring, *both* contestants receive credit for the points they score in each inning.

(a) Point Values - Each contestant may score zero (0), one (1), two (2), three (3), four (4), or six (6) points per inning.

(b) “Ringers Only” - A variation of count-all scoring where the contestants only receive credit for the *ringers* they pitch, for all innings of the game. In this format, each ringer is worth one (1) point. Each contestant may score zero (0), one (1), or two (2) points per inning. This type of scoring should be limited to higher percentage classes. **Note:** Single points are not countable in this pitching format.

Section B - Calling the Score

1. Cancellation Play

(a) Called By - The score shall be called to the scorekeeper by the contestant who scores one or more points, inning by inning. If no points are scored, the contestant who pitched second will call the score.

(b) The Correct Call - When calling the score, ringers (if made) shall be reported first, and then points (if made). **Note:** Contestants from different regions may use different phrases for calling the scores. (Recommended and alternative calls can be found in GUIDELINE 2.)

2. Count-all Play

(a) Called By - The score shall be called to the scorekeeper by only one of the two contestants, for the entire game, inning by inning. The person who calls the score shall be determined by Sanctioned League rules or by the Tournament/League Officials, or by the pitchers.

(b) The Correct Call - The caller shall report his/her score first, followed by the opponent's score. Since there are no cancelled ringers, only number scores shall be reported (see Section A.2, above).

Section C - Recording the Score

The score sheet (not the scoring device) shall be the official record of the game. When possible, contestants are encouraged to pay close attention to the score at all times. If a question or discrepancy occurs regarding the correct score, the contestants may approach the scorekeeper between innings (or during their half inning) to clarify the situation. If the discrepancy cannot be corrected to the satisfaction of both contestants, a judge or Tournament/League Official shall be called to make the final decision before play resumes.

RULE 7 - PITCHING ROTATION DURING THE GAME

Section A - Cancellation Rotation

After the flip of a shoe(s) or coin(s), the winner will choose who pitches first. If the game is to be played under cancellation scoring, there are two (2) ways to determine who will pitch first in the *next* inning, once the game has started. The method to be used shall be determined and announced before play begins, by the Tournament/League Officials.

1. Cancellation Play - The contestant who scored in the preceding inning shall pitch first in the next inning. If neither contestant scores, the contestant who pitched last in the preceding inning shall pitch first in the next inning.

2. Alternate First Pitch - Alternate first pitch is used to guarantee each contestant an equal number of first and second pitches during a game. It may also allow for differing playing conditions on any given court. If the game is to be played to a shoe limit, it is recommended that this limit be a number divisible by four (4). *Alternate first pitch shall be done in one (1) of three (3) ways, to be determined and announced/explained by the Tournament Director:*

(a) One contestant shall pitch first in innings 1, 4-5, 8-9, 12-13, 16-17, etc. while the other contestant shall pitch first in innings 2-3, 6-7, 10-11, 14-15, etc. until the game is completed. This is the fairest way and is recommended.

(b) One contestant shall pitch first in innings 1-2, 5-6, 9-10, 13-14, etc. while the other contestant shall pitch first in innings 3-4, 7-8, 11-12, 15-16, etc. until the game is completed.

(c) One contestant shall pitch first from one end of the court, and the opponent shall pitch first from the opposite end.

Section B - Count-All Rotation

Any game played using count-all scoring shall also use one of the alternate-pitch formats, described above in Section A-2.

Section C - Handicap Rotation

At the Tournament Directors discretion, an alternate pitch format may be used. (Also see Rule 11, Section F)

Section D - Pacer Rotation

If a pacer is used, the pacer will always pitch last, in every inning of the game. (see GUIDELINE 5 for additional information about pacers).

Section E - Pitching Out Of Turn

If it is discovered during an inning (before all four (4) shoes are pitched) that the wrong contestant has pitched first, the shoes pitched so far in that inning shall be re-pitched. If the error is not discovered until after all four (4) shoes have been delivered, they shall be scored as they lie and the original

rotation shall be re-established for the rest of the game. If no agreement can be reached, a judge shall be called. The judge shall either determine the scoring or void the inning and order it to be re-pitched.

RULE 8 - LENGTH OF GAMES, BREAKING OF TIE GAMES

Section A - Length of Games

There are three (3) options:

1. **Point Limit** - The game shall be played to a pre-determined number of points. Forty (40) points is a suggested amount. The first contestant to reach (or exceed) that amount is the winner.
2. **Shoe Limit** - The game shall be played to a pre-determined even number of shoes. Forty (40) or fifty (50) shoes is a suggested amount. When that number is reached, the contestant with the highest score is the winner.
3. **Point Limit or Shoe Limit** - For example, forty (40) points or fifty (50) shoes, whichever comes first. If the shoe limit is reached before the point limit, the contestant with the highest score is the winner.

Section B - Breaking of Tie Games (See also Rule 11, Section B)

There are two (2) options:

1. **Game Remains Tied** - Each contestant may receive 1/2 win and 1/2 loss. (This option *must* be used if a handicap system is in effect).
2. **Additional Innings** - A two-inning tiebreaker may be played, using the same method of play that was used to begin the game. In the event of another tie, this same procedure shall be continued until the tie is broken. **Note:** In "Point Limit or Shoe Limit" games (see A-3, above), the contestant who *may* reach (or exceed) the point limit *first* is the winner, at the completion of *any* extra inning.

RULE 9 - BROKEN OR CRACKED SHOES

Section A - Broken Shoes

1. **Upon Delivery** - If a shoe breaks into two or more pieces as a result of striking the stake, striking another shoe in the pit, or from landing into the pit substance, the pieces shall be removed and a replacement shoe shall be pitched in its place. If the shoe breaks when striking the backboard or other "foul" territory, it shall be considered a foul shoe and may not be re-pitched.
2. **After Delivery** - If a shoe has landed in the pit and becomes broken by having another shoe land on it, it shall be scored, as it appears to lie. If there is any disagreement, a judge shall be called. The judge shall either determine the scoring for the inning or order a replacement shoe to be re-pitched.

Section B - Cracked Shoes

If it is discovered that a shoe is cracked (but not completely broken into two or more pieces), it shall be scored as it lies. If there is any disagreement, a judge shall be called. The judge shall either determine the scoring for the inning or order a replacement shoe to be re-pitched. In any event, a cracked shoe must be replaced before the game can continue.

RULE 10 - LOOSE OR BROKEN STAKES

Section A - Loose Stakes

Stakes that are obviously loose, and can be easily moved out of position, shall be replaced before Sanctioned League or Tournament play begins. If a stake becomes loosened *during* Sanctioned League or Tournament play, immediate replacement is recommended. If this is not possible, care should be taken *not* to move the stake during the measurement of shoes. This stake shall be replaced before the next scheduled event.

Section B - Broken Stakes

If a stake appears to have become broken during sanctioned play, a judge or Tournament/League Official shall be called to make this determination before the stake or shoes are moved. If the stake *is* determined to be broken, the game shall be discontinued at the end of the previous inning and the stake shall be replaced. If a stake breaks as the result of being struck by the fourth shoe of the inning, then the inning may be counted. If the contestants cannot agree on this, then a judge shall be called to determine the scoring for the inning or void it and order the inning to be re-pitched, once the game resumes. Once the scoring for the inning is determined, the Tournament/League Officials may decide to resume play after the stake is replaced, to complete the game on another court, or to complete the game at a later time. A judge or Tournament/League Official will notify the contestants about resumption of play.

RULE 11 - TOURNAMENT/LEAGUE PLAY

Section A - Standard Method of Sanctioned Tournament Play

The standard method of NHPA Sanctioned Tournament play is round-robin play with contestants being seeded into classes using current ringer percentages imported from eShoe. Each contestant will play all other contestants in the Class. Court assignments and the order of play will follow a posted or printed schedule, normally given to each contestant at the beginning of the contest.

Section B - Determining Class Winners, Breaking of Class Ties

The Tournament Officials shall decide how Class winners are to be determined and how Class ties are to be broken and shall announce these procedures before tournament play begins.

1. Class Winners - At the end of round-robin play, win/loss records or ringer percentage shall determine Class winners. In addition, total points may be used if the scoring was done using the count-all method.

2. Class Ties - If ties occur, they shall be broken by playoff games, overall ringer percentage, who-beat-whom in the regular round-robin, or highest above/closest to their entering ringer average. Total points may be used if the scoring was done using the count-all method. In World, National, Regional and State Championships, all ties for first place in the *Championship Class* of a designated Division must be broken by a playoff game(s).

Section C - Ringer Percentage

A contestant's game and tournament ringer percentage shall be determined by dividing the total number of ringers by the total number of shoes pitched. Shoes pitched in playoff games and in extra innings pitched, because of tie games, shall be included in these totals.

Section D - Seeding Contestants

Contestants shall be seeded into Tournament Classes based on their current ringer percentage shown in eShoe at the time of the entry deadline. An exception could be the top seeding of a defending champion (not required) when his/her current percentages shall be based on the three (3) highest NHPA sanctioned events pitched in the preceding twelve (12) months, or among the last ten (10) sanctioned events pitched during the same period, whichever occurs first. The eShoe average ringer percentage is calculated by dividing the total number of ringers by the total number of shoes pitched for those three (3) events. If a Sanctioned League ringer average is one of the three (3) highest NHPA sanctioned events, that Sanctioned League ringer average shall be converted to an average that is based on four hundred (400) shoes.

1. No Current Average - Any contestant without a current ringer average at their pitching distance shall pitch a minimum of one hundred (100) consecutive shoes on a sanctioned court to establish their tournament seeding percentage. This qualifying must be scored in writing and witnessed by one (1) NHPA member no more than thirty (30) days prior to the entry deadline. **Note:** This 100-shoe qualifier is *not* a sanctioned event. Alternately, NHPA Sanctioned League ringer percentage averages may be used if they are based on one hundred (100) or more shoes.

2. Less Than Three (3) Events - Contestants with less than three (3) sanctioned events shall use the combined ringer percentage average of the one (1) or two (2) sanctioned events in which they have pitched. This may include the one hundred (100)-shoe qualifier described above.

3. Other Options - The number of sanctioned events required for entering Charter tournaments may vary and shall be determined and announced in advance by the Tournament/League Officials.

4. Physically Challenged Pitchers - a pitcher may apply to their Charter to reestablish a new ringer percentage due to a medical or physical issue. Upon approval from their

Charter, they can reestablish a new ringer percentage using current RGS Guidelines. This will be sent to NHPA Sec/Treasurer to input into eShoes.

Section E - Mixed Classes

If there are not enough entrants to form a competitive Class within a given Tournament Division (see Rule 1), contestants should be placed into more competitive “mixed” Classes where the overall ringer percentage “spread” will be less. Mixed Classes are not allowed at the World Tournament, but in Championship Classes of State Tournaments if divisions have fewer than 4 entries they may be mixed. (see also REQUIREMENT 3 “Mixed Play”, and REQUIREMENT 4 “Divisions”).

Section F - Handicapping

Handicapping may be used in open tournaments and in league play. The Tournament/League Officials shall determine the amount of the handicap. Class winners will be determined by win/loss record or, for count-all formats, by total points scored. At the Tournament Directors discretion, an alternate pitch format may be used. For the breaking of Class ties, the options in Section B (above) may also apply, except that ringer percentage shall not be used. Game handicapping shall not be used in any World, National, or Regional Tournament or in the Championship Class of a designated Division of any State Championship Tournament.

Section G - Forfeits

If, for any reason, a pitcher must forfeit a game prior to its completion, this player will receive a loss for that game and any accumulated statistics (shoes, points, ringers) for that game will be deleted from their records. His/her opponent will receive a win for that game and any accumulated statistics (shoes, points, ringers) will remain in his/her records.* A contestant may forfeit any number of games, due to illness, injury, or other legitimate reasons approved by the Tournament/League Officials, and still be permitted to return to the competition. Any contestant who forfeits such games will finish wherever their W/L record puts them in the standings, unless they forfeit for unapproved reasons (see NHPA Bylaws, Article III, Section 8, a-d). If so, they will not be allowed to return to the competition, will be moved to last place in the standings, and will forfeit all prize money and/or awards for that event. If forfeiting games for unapproved reasons, this contestant will also be subject to a one (1) year suspension from the NHPA (see NHPA Bylaws, Article III, Sections 8-11); to be decided later by the Charter and NHPA Officers.

* Please note: If a forfeited game is “in progress”, a Pacer should be used so that this game can be completed, for the opponent.

RULE 12 - APPROPRIATE NHPA MEMBER CONDUCT

Section A - On the courts

An NHPA member, while in competition, shall make no disturbing noises or movements that would distract the opponent or contestants on adjacent courts. Other inappropriate behavior would include profanity, abusive language, obscene gestures, etc. The first offense shall call for a warning from the judge or a Tournament/League Official.

A second offense shall call for a forfeiture of the game being played. Any further offenses shall call for a forfeiture of all games. This member shall also be subject to a one (1) year suspension from the NHPA (see Bylaws for additional information).

Section B - Sportsmanship

Any NHPA member who indulges in heckling or unfair rooting, uses profanity or abusive language, makes obscene gestures, or exhibits any other form of un-sportsmanlike conduct toward the contestants, Tournament/League Officials, or other NHPA members who are in the area of the courts, may be subject to expulsion from the Tournament/League and from the Tournament/League site. This member may also be subject to a one (1) year suspension from the NHPA (see Bylaws and page 34 for additional information).

Section C - Dress Code

All contestants competing in a World Tournament shall have, as a minimum, their last name and State or Country abbreviation professionally lettered on the back of their shirts. Said shirts cannot be sleeveless. No cut-offs are permitted and closed-toe shoes must be worn. Further dress code restrictions may be imposed by the Executive Council if all entrants are notified no later than the mailing date of their pitching schedules. This Dress Code may also be adopted into any Charter Bylaws or may be enforced at any State Championship Tournament or at any local tournament, if announced in advance by the Tournament/League Officials. Contestants who do not comply may not be allowed to participate in the event.

Section D - Alcohol, Tobacco Products, and Illegal Controlled Substances

During the World and State Championship Tournaments, the use of alcohol, any form of tobacco, or illegal controlled substances while in the confines of the courts shall be prohibited for all contestants, officials, and scorekeepers. This rule may also be adopted into any Charter Bylaws or may be enforced at any local tournament, if announced in advance by the Tournament/League Officials. Violations may result in the forfeiture of games.

Section E - Cell Phones

During the World and State Championship Tournaments, the use of cell phones shall not be allowed by anyone on the courts. This rule may also be adopted into any Charter Bylaws or may be enforced at any local tournament, if announced in advance by the Tournament/League Officials. Violations may result in the forfeiture of games.

Section F - Protests

If a contestant does not agree with a ruling or decision, a protest shall be made to the judge or Tournament/League Official(s) at the time the problem occurs.

If the problem cannot be resolved on the courts, the Tournament/League Official(s) shall make the final ruling on all protests. This ruling may occur after the game has been completed.

II. REQUIREMENTS

This section includes requirements (in addition to the Playing Rules) that apply for Tournament/League Officials, local Sanctioned Tournaments/Leagues, Charter/State Information, the World Tournament, Special Tournaments, and also for Cadet and Junior Pitchers. Violations of these additional requirements will be enforced by designated penalties or by other penalties assessed by the Tournament/League Officials, Charter Officers, or by the NHPA Executive Council.

REQUIREMENT 1 - TOURNAMENT/LEAGUE OFFICIALS

Section A - Duties and Responsibilities

All NHPA sanctioned tournaments and leagues shall have a designated director or committee to administer the activities of the event. The tournament/league officials shall:

1. Before the Event

- a. Publicize the event well in advance by using the Charter tournament schedule, by posting/distributing “flyers”, and/or by using all other available media. The information provided should include available Divisions, the date(s) and location of the event, amount of the entry fee, a prize list, the registration deadline, and any other special/pertinent information.
- b. If the tournament requires pre-registration, the Classes for each Division should be made up in advance and the contestants are to be seeded based on current eShoe averages (see RULE 11, Section D).
- c. Contestants should be notified of their pitching dates and times in a timely manner.

2. During the Event

- a. During sign-in, verify that all entrants are current NHPA members. Leagues can pitch non-members as pacers to encourage new players to participate.
- b. Arrange for scorekeeping for each court.
- c. Appoint an official judge(s) and provide them with judging tools, and a copy of the current RGS Book.
- d. Before Class play begins:
 1. Announce the method of play (cancellation or count-all), the length of the games (how many shoes or points) and information about alternate pitch, if it will be used.
 2. Announce how winners will be determined, and how game ties and class ties will be broken.

- 3. Announce the amount and method for paying scorekeepers (if used).
- 4. If scoring devices are used, provide the contestants with a name placard.
- 5. Provide a schedule and/or round-robin card of games to be played, including court assignments.
- e. Have statisticians available for the checking and recording of game scores and for the compilation of class results, as the tournament proceeds.
- f. Make the final decisions on any protests, and answer any questions that may arise.
- g. When necessary, make the decision to halt play due to inclement weather or other emergencies and decide when play shall resume, if or when conditions improve.
- h. Present the awards at the end of Class play.

3. After the Event

Tournament and League results must be recorded in eShoe upon completion of any tournament or league. See REQUIREMENT 2, Section I, below, for details and additional information.

REQUIREMENT 2 - ALL NHPA TOURNAMENTS/LEAGUES

All NHPA Tournament / Leagues shall be conducted at the discretion of the Tournament / League Officials, providing THE OFFICIAL PLAYING RULES, REQUIREMENTS, GUIDELINES, AND SPECIFICATIONS are followed.

Section A - Sanctioning

All NHPA Tournaments shall be sanctioned by the Charter Regional Director in accordance with the published guidelines or directives for NHPA Regional Directors. All NHPA Leagues shall be sanctioned by the Director of the NHPA SANCTIONED CLUB/LEAGUE PROGRAM.

Section B - Eligibility

Contestants having a national membership is considered a member with a current NHPA Full Member membership (see Bylaws for additional information on membership) and are given priority over other membership levels for tournament entry and league participation. This includes pacers and substitutes, except in League play where non-members can be used as pacers. Other eligibility requirements may apply for State tournaments and for the World Tournament.

Section C - Fees

All registration (entry) and any other fees shall be determined by the Tournament/League Officials.

Section D - Division Size

Any division not receiving at least four (4) entries can be canceled, but the entrants shall be given an opportunity to pitch in a Class of another Division.

Section E - Tournament Credit

1. For singles and doubles events, a contestant must have pitched a minimum of 100 shoes to receive eShoe credit.

Exception: If all games of the round-robin schedule have been pitched in less than 100 shoes, these statistics may be submitted for eShoe credit.

2. In team tournament competitions, any team member who has pitched a minimum of one hundred (100) shoes during that event may receive eShoe credit.

3. For elimination tournaments, a contestant must pitch one hundred (100) or more shoes to receive eShoe credit for that event.

Section F - League Credit

All seasonal, sanctioned Club/League play must be two hundred (200) or more pitched shoes to qualify as an official sanctioned event for eShoe purposes.

Section G - Count-All Scoring

The Count-All System of scoring is to be optional throughout any sanctioned event. The exception to this shall be the World and State Championship Tournaments where only the preliminary qualifying rounds may use the count-all method of total points to determine the Championship Classes.

Section H - Total Ringers/Shoes

All ringers and shoes pitched under one sanction number, including additional shoes for breaking of ties and play-off games, shall be included when figuring the totals for that event.

Section I - Reporting Results

1. **Tournaments** - All sanctioned tournament results must be recorded in eShoe. Results can be added/imported by charter RD's, statisticians, or tournament Directors. This should be done no later than two (2) weeks after the end date of the tournament. All indicated errors should be addressed immediately.

2. **Leagues** - League results must be sent to the NHPA Sanctioned Club/League Director as soon as possible, upon the completion of the league season. A period of not more than two (2) weeks is recommended. The Sanctioned Club/League Director will import the results into eShoe.

REQUIREMENT 3 - CHARTER/STATE INFORMATION

Section A - State Championship Play

Each Charter must hold an NHPA sanctioned State Championship event annually unless there is more than one Charter in the State, in which case the State Tournament will be rotated unless otherwise agreed upon by the involved Charters.

1. Divisions

The State Singles Championship Tournament must advertise and provide an entry form stating the intent to crown champions in at least Men, Women, Junior, and Elder Divisions. Other Divisions are an option left to the discretion of the tournament officials. All age limitations for Divisions shall be in accordance with RULE 1, Sections A-F.

2. Mixed Play and Handicapping (See also Rule 11, Section E)

The **Championship Classes** of the Open Men and Open Women Divisions in a State Singles Championship Tournament **should not be** mixed play. If, however, there are fewer than 4 entries in a championship division, there may be mixed play, determined by the State’s Executive Board and Tournament Director, attempting to separate pitching distances and Divisions as much as possible. All other Divisions and Classes may be mixed at the discretion of the Tournament Officials. When/if other Divisions are mixed, the Champion of each Division will be the highest finishing player (based on ringer percentage) in their respective Division. **Handicap formats** may be used in State Championship Class play, but any State Championship Division Title must be determined by a non-handicapped method of play.

3. Residency Eligibility

State Championship Tournaments are open only to those NHPA members who meet the regular eligibility requirements imposed for the event by the State Charter Bylaws. An exception to this shall be active-duty members of the U.S. Armed Forces and their immediate family who may pitch in the State Championship event of any State in which they are stationed/reside, provided they meet the other eligibility requirements of the Charter. No one will be allowed to pitch in more than one State Championship Tournament per year.

4. Full and Short Distance Pitchers

All sanctioned tournaments shall provide a playing opportunity for all eligible Full and Short distance pitchers. The NHPA Executive Council, in accordance with REQUIREMENT 5 (below), can authorize exceptions for special tournaments such as Invitationals, Juniors only, etc.

Section B - Newsline

All Charter officers must be members of the NHPA and have access to the official NHPA online publication “Newsline”.

Section C - Delegates

Only NHPA members in possession of a current combined State/National card are eligible to vote on any matter pertaining to the election of Charter officers,

the sanctioned tournament schedule, or anything else that may directly or indirectly involve NHPA business, Bylaws, or official Playing rules.

Section D - Compliance

Each Charter must comply in all ways with THE OFFICIAL PLAYING RULES, REQUIREMENTS, GUIDELINES, AND SPECIFICATIONS, and with the BYLAWS of the NHPA. Any deliberate violation of same will be cause for possible NHPA suspension of Charter Officers, the revocation of the Charter, or both.

REQUIREMENT 4 - WORLD TOURNAMENT PLAY

Section A - Committee and Director

The World Tournament Committee shall consist of all members of the NHPA Executive Council present at the World Tournament. The NHPA President shall designate the World Tournament Director who will confer with the President on the format and schedule.

Section B - Divisions

A World Tournament shall include separate Championship Divisions for Juniors, Cadets, Open Men, Open Women, Seniors, and Elders. If Class pitching performance is used as a "qualifier" for determining who will advance to Championship Division play, the Championship rounds shall be assigned a separate sanction number and both Class and Championship play shall each count as a separate tournament.

Note: Qualified Alternates in Championship Divisions
Unless the tournament director has been contacted, contestants who have not checked in before the scheduled pitching time shall forfeit all games and be replaced by a qualified alternate. For Championship Divisions, alternates are determined by the results of Class Play and their names will be announced at that previous awards ceremony.

Section C - Championship Finals

Finalists in each World Championship Division will be determined by averages in eshoe and/or by the results of preliminary Class play within their Division. All contestants will be seeded according to their ringer percentages.

Section D - World Title

The title of Champion Horseshoe Pitcher of the World can be contested for only in tournaments authorized by the NHPA Executive Council.

Section E - Division Winners

The winner of each Division of the authorized World Tournament shall be declared the Champion Horseshoe Pitcher of the World for their respective Division, and shall hold this title until the next authorized World Tournament.

Section F - Playoffs

In World Tournament play, games won and lost shall determine the order in which the winners are placed. If there is a tie for first place, a playoff game will determine the winner. All play-off games will follow the same format as the round-robin play

for that Class. If more than two players tie for first place, a ladder-type playoff will be used, based on ringer percentages in that competition. All other ties (second place and below) will be determined by ringer percentage. If still tied, “who beat who”, and then “ringer % vs entry %” will be used. Note: Percentage ties for all move-up positions shall be broken by a playoff game. If still tied, additional innings will be played (see Rule 8, Section B.2). NOTE: If a shoe-limit play-off game ends in a tie, extra innings (see RGS Rule 8, Section B-2) will be used to break this tie.

Section G - Records

Any record set in any Sanctioned Tournament shall be called a World Record. Any record set in a World Tournament shall be called a World Tournament Record. These statistics are to be recorded as two different sets of records. The NHPA Executive Council will decide on the authenticity of any disputed record.

Section H - Eligibility

All entrants shall have their eligibility and entering percentage verified in eShoe.

1. **Qualifying Events** - All adult entrants to the World Tournament who reside in the United States or Canada must have completed at least four (4) NHPA or HCA sanctioned events at their Division pitching distance during the twelve (12) months preceding the cut-off date listed on the current World Tournament entry form. **Note:** Only one event is required for Juniors and Cadets.
2. **Exemptions** - An exception to the requirement of four (4) sanctioned events shall be active-duty members of the U.S. Armed Forces and their immediate family (if married), provided they meet the other eligibility requirements. Entering averages for foreign entrants and active-duty members of the U.S. Armed Forces and their immediate family, not in the eShoe database, will be verified by other means. (See RULE 11, Section D.1)

Section I - Awards

The Prize and Trophy list will be developed and approved by a majority of the NHPA Executive Council members. This award list will also be published for the NHPA membership, in a timely manner.

1. Minimum cash awards are as follows:

- a. The Championship Division cash prize list, including the Junior prize amounts, will be paid from the NHPA funds collected and based upon the \$3.00 set-aside for each adult member reported from the previous year.
- b. The Men’s Open Championship cash prize for first place shall be a minimum of \$2,500 and the Women’s Open Championship cash prize for first place shall be a minimum of \$2,000.
- c. The Executive Council shall determine an amount of money, not to be less than \$3,000, to be added to the World Tournament cash prizes. This money may come from any source available to the NHPA Executive Council.

REQUIREMENT 5 - SPECIAL TOURNAMENTS OR EVENTS

Section A - Events

The NHPA Executive Council may authorize or conduct, at its discretion, special/promotional tournaments, matches, exhibitions, open, invitational, or celebrity pitching events, anywhere that it deems suitable.

Section B - Waiver

Any Special tournament or event, including the World Tournament, will be conducted in accordance with THE OFFICIAL PLAYING RULES, REQUIREMENTS, GUIDELINES, AND SPECIFICATIONS except that the NHPA Executive Council may approve a waiver if it will aid in the promotion of the sport and/or success of the event. The NHPA Executive Council may authorize a limit to the number of entries to any Special Tournament or Special Event if it feels time, available courts, or any other conditions make it impossible to reasonably schedule an unlimited number of entrants. In such cases, limits may be set by any manner deemed suitable.

REQUIREMENT 6 - CADET AND JUNIOR PITCHERS **Additional Information** (See also RULE 1, Section A)

Section A - Juniors Competing in Adult Divisions

Any Junior Boy or Junior Girl pitcher may compete in an Adult Division of a mixed tournament without harm to their Junior standing provided neither of these Junior Division Classes is offered/available in that same tournament. When a Junior Division *is* offered, a Junior may pitch with the adults (without harm to their Junior standing) if their entering average is at least ten (10) percent higher than the next closest Junior.

Note: This same requirement will also apply to Cadets; for their movement into other Divisions.

Section B - Eligibility

Junior pitchers who request admittance and are accepted into an adult class outside the conditions set forth in Section A above, will forever forfeit their Junior eligibility. A Junior Boy who forfeits his Junior status must pitch from the full distance.

Note: The same above requirements will apply to Cadets; for their movement into the Junior Division.

Section C - Awards

Awards presented to a Junior or Cadet by the tournament/league officials may have immediate or deferred monetary value.

Section D - Responsibility

Collegiate: Prizes or cash awards for horseshoe pitching achievements do not impact amateur status in any NCAA sports. (Horseshoe pitching is not a NCAA sport)

Scholastic (High School): It is the responsibility of the youth participant and their parents/guardians to check state scholastic sport association regulations/restrictions when determining whether to accept an award with any monetary value. The

host charter and/or the NHPA assumes no responsibility for any adverse effects which horseshoe pitching awards may have on the amateur status of any youth participant.

III. GUIDELINES – The Guidelines section provides suggestions/recommendations for sanctioned league and/or tournament play, including suggested formats for Doubles Play. Also included here are guidelines for calling the score, keeping score, judging, and the use of pacers.

GUIDELINE 1 - DOUBLES PLAY

In doubles play, two contestants are partners against another team of two contestants. One contestant from each team will be at each end of the court and the tournament officials should match the contestants so that the highest rated contestant (by percentage) from each team will be pitching from the same end of the court. The Tournament Committee will determine the length of the game and method of play. When contestants are pitching their shoes, the contestants at the other end should be well behind and to the side of the pitcher's box (for their own safety) and in a stationary position so as not to distract the contestants on their own or adjacent courts. Otherwise, all the Playing Rules for singles play shall apply.

Section A - Regular Doubles

In regular doubles, both team members use the same pair of shoes and all contestants stay at the same end of the court for the entire game. To begin the game, the Tournament Director will determine who starts the pitching and how the pitching rotation continues. Their partners, at the opposite end, will decide on and call the score, retrieve the shoes, and pitch them back following the same procedure. The decision on who pitches first in each inning depends upon the scoring system being used, following the rules of singles play. A single score sheet should be used that clearly shows the ringers and shoes pitched by all contestants.

Section B - Walking Doubles

In walking doubles, all contestants will pitch their own shoes. A single score sheet should be used that clearly shows the ringers and shoes pitched by all contestants.

- 1. Shoe-limit Games** - The Tournament Director will determine who starts the pitching rotation and how the pitching rotation continues. The pitchers at both ends will pitch their shoes and then walk to the other end and decide the scoring and pickup their shoes. Which one of them (and their opponents) pitches first depends upon the scoring system (cancellation or count-all) being used, following the rules of singles play. This procedure will continue until the game is over.
- 2. Point-limit Games** - The Tournament Director will determine who starts the pitching and how the pitching rotation continues.

The partner of the pitcher who scores (or the partner of the contestant who pitched last, in case of a no-score situation) will call or record the score and will pitch first in the next inning. All pitchers will now walk to the opposite end. The highest-rated contestants will pick up their shoes (already scored) and step back. The scoring of the last four (4) shoes pitched will be determined and called or recorded. The contestant calling the score always pitches first. This procedure is continued until the game is over. For safety or other reasons, the Tournament/League Officials may select an alternative walking sequence, as long as the scoring sequence remains the same.

GUIDELINE 2 - CALLING THE SCORE

When calling the score, ringers (if made) shall be reported first, and then points (see RULE 6, Section B, 1-b).

Section A - Recommended Calls

Here are the **recommended** calls for points allowed, in the following situations:

- No ringers with the closest shoe in count - call "one point".
- No ringers with the two (2) closest shoes in count - call "two points".
- One (1) ringer with either no shoe in count or the other contestant having the closest shoe in count - call "one ringer, three points".
- One (1) ringer with the closest shoe in count - call "one ringer, four points".
- Two (2) cancelled ringers with the closest shoe in count - call "two dead, one point".
- Two (2) cancelled ringers with one (1) un-cancelled ringer - call "two dead, three points".
- Two (2) un-cancelled ringers - call "two ringers, six points".

Note: No points shall be awarded in the following situations:

- » All four (4) shoes out of count - call "no score".
- » Two (2) cancelled ringers with no other shoes in count - call "two dead, no score".
- » Four (4) cancelled ringers - call "four dead".

Section B - Alternative Calls

As different phrases may be used in different regions of the country, here is a list of some of the more common **alternative** calls to become familiar with. **Note:** The recommended call (**in bold type**) is listed first, followed by most of the alternative calls that are used.

- » **one point** - (usually the same)
- » **two points** - (usually the same)
- » **one ringer, three points** - "one ringer three", "ringer three", "three points"
- » **one ringer, four points** - "one ringer four", "ringer four", "four points"

- » **two dead, one point** - “one ringer each, one point”, “ringer each, one”, “ringers alike, one”
- » **two dead, three points** - “three ringers, three points”, “three on three”, “three on a double”, “three, three”, “ringers alike, three”
- » **two ringers, six points** - “two ringers, six”, “six points”. “six”
- » **no score** - (usually the same), “nobody”, “nobody home”
- » **two dead, no score** - “one ringer each, no score”, “ringer each, no score”, “ringer each, nobody”
- » **four dead** - (usually the same), “two ringers each, no score”, “four ringers, no score”

Section C - Recommended Hand Signals

The use of hand signals is optional, but very helpful to scorekeepers who may have difficulty hearing verbal calls, for a wide variety of reasons. Though there may be more than one hand signal for some calls, the following are based on written survey results, and from discussions and the recommendations of many scorekeepers. Alternate hand signals, for some calls, can be found in Newsline Magazine articles and/or on the NHPA website.

A. Calls/Signals for Cancellation Play: (Review Rule 6, Section B.1 - Calling the Score)

‘No Score’



‘One Point’



‘Two Points’



‘One Ringer, 3 Points’



‘One Ringer, 4 Points’



‘Two ringers, 6 Points’



“Two Dead”

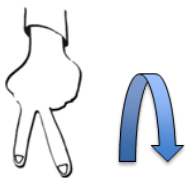

“Four Dead”

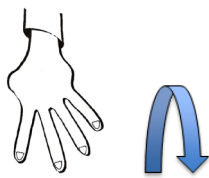

(After the ‘two-dead’ signal, add either the ‘no score’, ‘1 point’, or ‘3 points’ signal. After the ‘four-dead’ signal, a ‘no-score’ signal can be added)

B. Calls/Signals for Count-All Play: One person calls two scores; his/her score first, and then the opponent’s score. Using the ‘number’ hand signals from above, but add ‘zero points’, shown here. (Also review Rule 6, Section B.2 - Calling the Score)

(Four examples of possible scores)

‘Zero Points’



Call - ‘Zero, two’

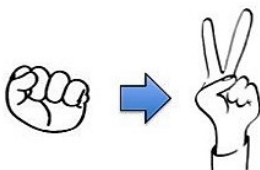

Call - ‘two, four’

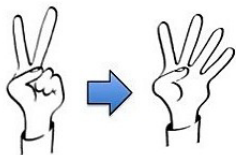

Call - ‘three, three’

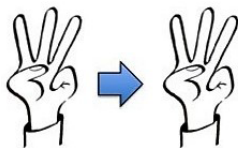

GUIDELINE 3 - KEEPING SCORE

Requirements and Suggestions

Scorekeeping is a very essential part of the sport of horseshoe pitching. To ensure that scoring errors do not occur during the competition, all scorekeepers must be familiar with the type of game being played, the score sheets, the round robin cards, and the scoreboard or electronic score-keeping device being used. It is also most important that scorekeepers: 1) understand how scores are being called, 2) know how many ringers may be associated with the numbers being called (see GUIDELINE 2 above), and 3) know how to credit each contestant accordingly.

Section A - Before the Game

Individuals interested in supporting the game by keeping score should inform the Tournament/League Officials of their intent. Usually, a sign-up sheet for scorekeepers is available, listing the time and date for classes of play. Once signed up, individuals are expected to be available on a timely basis. If for some reason they are unable to keep the scheduled signup, the Tournament/League Officials should be notified accordingly.

- 1. Proper Dress** - Scorekeepers should be comfortably dressed, and handle personal matters before entering the court area.
- 2. Score Sheets** - It is the responsibility of the Tournament/League Officials to provide the required score sheets at all designated courts. The score sheets should be examined to determine that they were properly distributed, and then make sure (by reviewing their round robin cards) that the correct contestants are ready to compete. Scorekeepers should sign all score sheets in case there may be questions later.

Section B - During the Game

All personnel within or near the court complex should be attentive at all times. Scorekeepers should keep their movement to a minimum, and be especially alert for contestants that are in the process of practice or competition, so as not to disturb the contestants and to avoid getting hit by pitched shoes.

- 1. Recording the Score** - When the score is called, the results should be immediately posted on the scoreboard, or scoring device. Scorekeepers should then record the ringers and points scored on the score sheet and keep the game scores current. The scorekeeper should be prepared to stop the game when the agreed-to limit on shoes pitched or total points is reached.
 - a.** Symbols are used on score sheets to indicate ringers. "Live" ringers are shown with a circle "O" and "canceled" ringers are shown with an "X". This makes it convenient to summarize, if necessary, and for proofing the score sheet for errors.
 - b.** It is very important that scorekeepers record all ringers to assure that both pitchers receive credit for ringers they pitched, whether live or canceled. "POINTS" column entries should show the number of points called out to

the scorekeeper for each inning while the "SCORE" column entry should show each pitcher's accumulated score subtotal.

Section C - After the Game

During and at the end of each game, the scorekeeper should make certain the scores are properly tallied, and then fill in the round robin cards, if used. When the game has concluded, the contestants should remain at the end of the courts until the score sheet and round robin cards have been completed. Properly completed and signed score sheets will be collected as directed by the Tournament/League Officials. **Note:** The score sheet (not the scoreboard) shall be the official record of the game. (See RULE 6, Section C)

Section D - Scoreboards

For the benefit of spectators and contestants, scoreboards may be positioned at the courts. If so, once the score is recorded on the scoreboard, the correct score should then be marked on the scoresheet, being cautious at all times not to disturb the contestants.

Section E - Electronic Scoring Devices

Various programs can be made available for electronic scoring; consequently the scorekeeper should be familiar with the program being used.

Section F - Hand Signals

Certain contestants regularly use hand signals to indicate their score. If this creates a score keeping problem, the contestant(s) should be informed accordingly and asked to use the common score calls in GUIDELINE 2 above.

GUIDELINE 4 - JUDGING

Section A - Responsibilities, Expectations and Duties (also see Judging Guidelines booklet)

Judges are to be appointed by the Tournament/League Officials.

1. Responsibilities

- a. To enforce the rules and issue the proper penalties if and when violations occur.
- b. To measure for ringers, the closest shoe to the stake, or for shoes in count.
- c. To resolve scoring questions or discrepancies, and to answer or resolve any rules questions, when called upon by the contestants.
- d. To help make the correct decision in situations involving broken shoes, broken stakes, shoes and or stakes that may be moved by contestants during measurements, shoes pitched out of turn, a contestant's shoes mistakenly pitched by the opponent, and other questions which may arise.
- e. To act as a liaison between the contestants and the Tournament/League Officials for all possible questions or situations.

2. Expectations and Duties

- a. During competition, judges should always be available and remain visible to the pitchers. Wearing an orange vest is recommended.
- b. Judges should be very familiar with the Playing Rules and should have a copy of the current rules with them for reference, if needed.
- c. Judges should be reasonably healthy, with good hearing and eyesight.
- d. In addition to their duties, judges should also help out on the courts, where needed. They may be asked to assist with items like keeping watering containers filled, spray paint available, or with picking up score sheets.

GUIDELINE 5 - PACERS (See also RULE 7, Section D)

Section A - Use of Pacers

All contestants, including pacers and/or league substitutes, must be current NHPA members (see page 7 under PLAYING RULES; also see Bylaws for information on membership). Pacers are commonly used in place of contestants who have entered a tournament but, for various reasons, do not show up. They may also be used when contestants have to drop out of a tournament due to illness.

Section B - Qualified Pacers

Pacers should pitch from the same distance as the others contestants in the Class, unless the Class is "mixed". They should also be close to or within the same percentage "spread" as the Class and, if possible, wear a shirt with their name and State on the back.

Section C - Awards and Statistics

Since pacers are not "official" contestants in the Class competition, their games will always appear in the "loss" column, they are not eligible for prizes or awards, and their statistics are not to be entered in eShoe. Also, they may or may not be asked to pay the scorekeeper for the games they pitch.

GUIDELINE 6 - UN-SPORTSMAN-LIKE BEHAVIOR

(also see NHPA website)

NHPA recommendations for the handling of un-sportsman-like behavior at sanctioned events.

The following information is published here to provide guidelines for members, tournament Directors/Committees, Regional Directors, and Charter Officers to consider and use in dealing with undesirable or unacceptable behaviors seen or heard in the area of the courts during NHPA sanctioned events. The possible consequences included here are NHPA recommendations and have been arranged, more or less, from the least severe to the most severe.

LEVEL 1 - *A verbal reminder by the TD to the offender that the behavior is inappropriate.* This reminder could be made by any member to the TD, either during or after the game/event. This verbal reminder could be repeated a second time, before moving to level 2.

LEVEL 2 - A verbal reminder followed by a written notice.

A verbal reminder/warning to the offender PLUS a written notice that states the inappropriate behavior and that this behavior will not be tolerated in the future. This written notice or a standard/completed form (available upon request) could be sent by the TD, the RD, or by a designated Charter Officer. Charter Officers should be notified about and approve this written notice in advance of it's being sent. This could be repeated a 2nd time, before moving to level 3.

LEVEL 3 - A written notice of suspension from this tournament/league for a designated period of time.

One to twelve months is suggested. A written notice or form describing the inappropriate behavior and consequence should be sent to the offender by the TD, the RD, or by a designated Officer. Charter Officers should be notified and approve this suspension in advance, and a copy of this suspension notice will be sent to all tournament Directors of other tournaments where this pitchers normally pitches.

LEVEL 4 - Suspension from all Charter Tournaments and/or Leagues for a designated period of time.

Not less than 4 months or more than one year is suggested. Under these terms, the offender would be allowed to participate in any other Charters/State events, and could still qualify for entering the WT. The NHPA must be involved in this suspension process, and must approve the suspension in advance. Other States/Charters where this offender may pitch (Located in eShoe) should be notified of this suspension and should notify the NHPA of any future misconduct.

LEVEL 5 - Suspension from the NHPA for a designated period of time.

Six months or a year is suggested. The NHPA must be involved in this process and must approve this suspension in advance. Written notification should be sent by the Charter President or NHPA President, upon approval of the NHPA Council.

NOTE: Depending on the severity of the offense, the consequence issued could begin at any of the above levels. The first 3 levels should be handled at the charter level, but for levels 4 and 5, the NHPA Vice President in charge of Grievances and Suspensions must become involved in the process.

IV. SPECIFICATIONS

The Specifications Section includes information about specific measurement requirements for equipment and for court layout (including Covered and Indoor Courts), the sanctioning of horseshoes and courts, and the allowable repairs for horseshoes. Diagrams are included here (see back covers), but for individuals or clubs that are constructing new courts, detailed plans can be found on the NHPA website at www.horseshoepitching.com.

I - EQUIPMENT SPECIFICATIONS

Section A - Sanctioned Horseshoes (also see diagram on page 49)

All horseshoe designs and prototypes must be approved and sanctioned by the NHPA before the shoes they represent

can officially be manufactured and used in NHPA sanctioned competition. The maximum weight and measurement standards are as follows: The horseshoe weight shall not be more than two (2) pounds, ten (10) ounces (there is no minimum weight). No horseshoe can exceed seven and one-quarter inches (7-1/4") in width or seven and five-eighths inches (7-5/8") in length. The opening of the shoe must not exceed three and one-half inches (3-1/2"), measured from a parallel line three-fourths of an inch (3/4") inward from a straightedge touching the tips of the shoe points. (A one-eighth inch (1/8") tolerance to three and five-eighths inches (3-5/8") is allowed on used shoes) No part of any horseshoe shall exceed one inch (1") in height when placed, with calks down, on a level surface. Shoes not meeting these requirements shall be declared "illegal". Illegal shoes shall not be used in any NHPA sanctioned competition and all games pitched with illegal shoes shall be forfeited. All horseshoes used by a pitcher may be checked at any time, before or during competition, to verify that they are legal shoes. A judge or other Tournament/League Official will do this checking. (see Bylaws, Standing Rules 7 & 8 for additional information)

Section B - Altered Horseshoes

Any sanctioned shoe that has been physically and permanently modified from its original design (calk, notch, etc.) shall be considered an "altered" shoe. In addition, no shoe can be temporarily modified, with the exception of painting. An "altered" shoe is illegal and cannot be used in any sanctioned event. Contestants using altered shoes in a sanctioned event shall be subject to penalties, which could include a one (1) year suspension from the NHPA (see Bylaws for additional information). **Note:** The NHPA Executive Council has the right to waive the "altered" shoe provision for a physically challenged contestant.

Section C - Legal Horseshoe Repair

Through prolonged use, horseshoes may become bent or warped and "mushrooming" or "roll-over" may occur on the inside of the "toe" area, or elsewhere. Horseshoes may also crack or break into two or more parts. When possible, these conditions may be corrected by filing, grinding, heating, pounding, or welding of the shoes, so long as the original design of the shoe is not altered in the process and so long as they still meet all of the measurement requirements for NHPA sanctioned horseshoes. (see Section A above)

Section D - Horseshoes Sanctioned in Other Countries

Any horseshoes sanctioned in other countries may be used during NHPA sanctioned play, but only by contestants from that country, and only if the shoes meet NHPA horseshoe specifications. They are not allowable for use by U.S. citizens in NHPA sanctioned events unless the horseshoes have also been sanctioned by the NHPA. (see Section A above)

Section E - Pitching Accessories

It is legal for a contestant to carry and use a blunt-ended hook or horseshoe pick-up device, but it cannot exceed thirty-six inches (36") in total length. Any hook cannot protrude more than two inches (2") from the main shaft. Care should be

taken in using the hook so as not to endanger the opponent or other contestants. Contestants are also encouraged to carry measuring tools as well as a file and towel to keep their shoes burr-free and shoes/hands clean and dry. **Note:** All measurement tools manufactured for sale through GRS must be pre-approved by the NHPA Council.

II - SPECIFICATIONS FOR COURT LAYOUT (also see diagram on inside back cover)

Section A - Sanctioning of Courts

Court conditions inconsistent with the NHPA specifications listed below are discouraged primarily because of the need to standardize the conditions and results of play for all pitchers. All NHPA sanctioned events must be contested on fully or conditionally sanctioned courts. These courts must be re-sanctioned by the Charter RD (or designates) every four (4) years, beginning in 2007.

- 1. Full Court Sanction** - Permanent, in-ground courts that meet all of the specifications listed below in Section B may receive a Full Court Sanction Certificate from the Regional Director of that Charter, once these specifications are verified. Any sanctioned league or tournament may be contested on these courts. The use of fully sanctioned courts is highly recommended for all Charter State Tournaments and may be required by some Charter Bylaws.
- 2. Conditional Court Sanction** - The NHPA recognizes that while some older permanent, in-ground courts may not meet *all* of the court sanction specifications listed below in Section B, all courts constructed *before* January 1, 2007 *must meet the basic court requirements of:* 1) correctly marked foul lines, 2) minimum pit dimensions, 3) specified stake diameter and placement, 4) specified stake height and angle/lean, 5) legal pit material of minimum depth, and 6) a protective barrier surrounding the courts. In addition, (effective 2019) these pre-2007 court complexes must have at least three (3) courts with short-distance pitching platforms to provide for a 6-person class which may include Women, Elders, and Junior Boys or Junior Girls. These specifications are detailed in Section B, below. Upon verification of these basic requirements by the Regional Director, a Conditional Court Sanction Certificate may be issued and sanctioned events can then be contested here. All clubs are encouraged to work annually on any remaining court improvements and to strive for fully-sanctioned courts. **Note:** All courts constructed *after* January 1, 2007 must meet *all* of the court specifications listed in Section B and become fully sanctioned. In some cases, the NHPA Chairman of Regional Directors may grant a *temporary* court sanction waiver for specified non-basic requirements so that sanctioned league and/or tournament play can begin in a timely manner (see Court Sanction Waivers, below).
- 3. Portable Raised Pits** - Portable raised pits may be sanctioned by the Regional Director so long as they meet all of the construction specifications set forth in Section C (below) and also meet the six (6) basic court set-up requirements, named above and that are detailed in Section B (below). Any sanctioned event may be contested on these sanctioned portable courts.

- 4. Court Complexes** - Since only one court sanction certificate will be issued in locations where there are multiple courts, *all courts within the complex* must meet the specified requirements for the issuance of a Full Court Sanction Certificate, or for the issuance of a Conditional Court Sanction Certificate.
- 5. Court Sanction Waivers** - Waivers for some non-basic court requirements may be granted if approved by both the Charter Regional Director and the NHPA Chairman of Regional Directors. **Note:** A Conditional Court Sanction Certificate is to be issued in all cases where any waivers have been granted.
- a. Temporary CS Waiver** - Issued for a specified and reasonable period of time; where additional time may be required for the completion of work, for example.
- b. Permanent CS Waiver** - Issued to some indoor or older outdoor court complexes for an indefinite period of time where the current specifications cannot be easily met and/or where existing conditions seem unreasonable to change. Example - Concrete pitching platforms or walkways that may be a few inches less than the specified eighteen inch (18") width requirement.
- c. A Special Waiver** - Any portable or in-ground courts that measure less than the specified thirty-one inches (31") inside width, but not less than twenty-nine inches (29") inside width, and were built prior to 2007, will be granted a permanent court sanction waiver and considered conditionally sanctioned, provided they meet the remainder of the minimum basic requirements. Should these courts ever be refurbished, they must be modified to meet the original thirty-one inch (31") minimum inside width at that time. The sidewalls of these waived courts are still considered foul territory, and any live shoe that touches, comes to rest on, or is directly above the sidewall is considered a foul shoe, regardless if it is within six inches (6") of the stake.
- d. Other Court Sanction Requirements** may be waived by the Chairman of Regional Directors and/or the NHPA Council under special circumstances, some of which are explained more fully in REQUIREMENT 5, Section B).

Section B - Court Sanction Requirements/Specifications

- 1. Court Dimensions** - The rectangular playing area of a horseshoe court shall be six feet (6') wide and forty-six feet (46') long. An additional two feet (2') of buffer zone, along each side and behind each pitching box, is recommended for safety reasons. This combination of measurements results in an overall court area that is ten feet (10') wide and fifty feet (50') long. All surfaces within this area shall be level. A north-south orientation for outdoor courts is recommended, to minimize the effects of sunlight.
- 2. Court Surfaces** - There are no specific court surface material requirements other than the use of suitable pit substances (see #9, below). The same surface

crossover areas surrounding the pit. For outdoor courts, recommended materials for all walkways, platforms, and crossover areas include concrete or paved asphalt. For indoor courts, concrete, wood, or suitable carpeting is recommended for all platforms and crossover areas. Other court surfaces may consist of any natural or man-made material, so long as it provides a safe, non-skid surface. Suitable drainage of surface water away from pits and platforms is recommended for outdoor courts. Shrubs, signs or other objects must not block the view of pitchers or interfere with their necessary movements on the court.

3. Multiple Courts - In facilities with multiple courts, the following layout guidelines shall be observed:

a. Side-by-side Courts - For safety reasons and to minimize distractions, the stakes of adjacent courts must be no closer than ten feet (10') apart. A distance of twelve feet (12') is recommended.

b. Back-to-back Courts - The stakes of back-to-back courts must be a minimum of sixteen feet (16') apart and a visual and protective barrier (a minimum of six feet (6') high is recommended) must separate the courts.

4. Pitcher's Box - The pitcher's box is a six-foot (6') by six-foot (6') area at each end of the court. It is composed of two main parts: The Pit, and the Pitching Platforms. The back of each box should be forty-six feet (46') from the back of the opposite box.

a. The Pit - The pit is a rectangular area filled with the "pit substance" into which the shoes are pitched. The *maximum inside length* of the pit (in the direction in which the shoes are pitched) is seventy-two inches (72") and the *minimum inside length* is forty-three inches. (43") The *maximum inside width* is thirty-six inches (36") and the *minimum inside width* is thirty-one inches (31"). The pits shall be centered on the courts' lengthwise centerline, which is also midway between the full-distance pitching platforms. For safety reasons, the use of sideboards to contain pit material is not recommended. If used, they shall not exceed a height of seven inches (7"). **Note:** The areas behind and in front of the pit are referred to as "crossover" areas. (see RULE 3, Section D.3)

b. Pitching Platforms

1. Full-Distance Pitching Platforms - These pitching platforms flank each side of both pits and are parallel to each other. They shall be eighteen inches (18") to twenty and one-half inches (20-1/2") wide (depending upon the width of the pit), shall be a minimum of six feet (6') long, and shall provide a non-skid surface.

2. Short-Distance Pitching Platforms and Walkways
The pitching platforms, on each side of both pits, shall be extended forward an additional ten feet (10') to accommodate short-distance pitchers, or for the full length of the court (recommended) to provide a continuous walkway. These platforms shall be level

with and be of the same width as the full-distance platforms. The surface material should be the same as the full-distance pitching platforms.

- 5. Imaginary Stakes** - Imaginary stakes are a useful reference, for short-distance pitchers, on where to stand. They shall be marked (often by a spot of paint or other marker of the same diameter as the official stake) midway between the extended platforms, or on the inside edge of the extended platforms, at distances of thirty feet (30') and twenty-three feet (23') from the opposite stake.
- 6. Stakes** - The stake is the target at which the shoe is pitched. Stakes shall be positioned in the very center of the pitcher's box, on the court's lengthwise centerline, with a minimum of twenty-one inches (21") from the stake to the front and back of the pit substance. The distance between stakes shall be forty feet (40'). This distance is to be measured from the front of each stake, level with the pitching platform. Stakes shall be one inch (1") in diameter and shall be made of cold-rolled steel, mild iron, soft metal, or NHPA-approved synthetic material. The top of each stake shall be no less than fourteen inches (14") and no greater than fifteen inches (15") above the level of the pitching platforms (see exception for raised pits in Section C) Stakes shall be securely mounted (see diagram on page 46) and have a three inch (3") lean toward the opposite end.
- 7. Foul Lines** - Foul lines shall be defined by straight lines extending across the full-distance and extended platforms and shall be placed perpendicular to an imaginary line between the stakes. The thirty-seven foot (37') and twenty-seven foot (27') foul lines shall be measured from the front of the opposite stakes. A single, twenty-foot (20') foul line shall be marked on each platform at the exact mid-point between the stakes. Foul lines shall be measured at the level of the pitching platforms (see exception for "Raised Pits" in Section C, below). While the width of foul lines may vary (two inches (2") is recommended), their location shall be marked in a way that is clearly visible to the pitchers and judges.
- 8. Backstops/Backboards and Protective Barrier**
 - a. Backstops/Backboards** - For safety reasons, every pit should have a backstop/backboard. It shall be at least three feet (3') behind the stake, be at least one foot (1') high, and extend to the width of the pit. For spectator visibility, a mesh netting or chain-link material is recommended. If made of solid material, it should be a color that will provide a contrasting background so as to make the stake more visible for the contestants. **Note:** The backboards of raised/portable pits are usually attached to the inside of the wooden framework and may therefore be as close as twenty-one inches (21") to the stake.
 - b. Protective Barrier** - For safety reasons, all court complexes shall be surrounded by a protective barrier. This barrier should be at least eight feet (8') behind the stakes. A chain-link type of fence at least four feet (4') high is recommended.

9. Pit Substance - Clay, sand, dirt and NHPA-approved synthetic materials are all legal pit substances. The *minimum* depth of the pit substance shall be four inches (4"). An eight inch (8") depth is recommended for in-ground pits.

10. Overhead Court Clearances - The air space above all courts shall be free of all natural or man-made objects such as tree limbs, wires, etc. for a height of at least twelve feet (12') above the playing area.

Section C - Specifications For Raised Pits

Also known as temporary or portable pits, raised pits are often used for events of a relatively short duration such as the world tournament, a local fair, or an exhibition. Normally constructed of treated plywood and framing lumber (2X4s and/or 2X6s), the height of the pit framework shall not be more than seven inches (7") above the level of the adjacent pitching platforms. For sanctioned events, the minimum inside dimensions shall be the same as stated in Section B, 4.a above. (See exception in Section A-5.c) After the proper positioning of the stakes/pits (see Section B.6, above), the thirty-seven foot (37') and twenty-seven foot (27') foul lines shall be measured/marked from the front/base of the opposite stake before the pit substance is added. The stakes/pits should be anchored in such a way that they will not move during their use. The top of each stake shall be no less than eighteen inches (18") and no greater than nineteen inches (19") above the inside, bottom of the pit. The pit substance in the scoring area surrounding the stake shall be maintained at a depth of four inches (4"), between games.

Section D - Specifications For Covered and Indoor Courts

The specifications for covered and indoor courts are exactly the same as for permanent ground level courts with the additional stipulation that they shall have a minimum twelve-foot (12') vertical clearance for shoe trajectory, at or near mid-court.

GLOSSARY

This glossary includes the definitions for most of the horseshoe terms used in this RGS Book, and for terms found in other horseshoe-related literature. To make them easier to find, these terms/definitions are arranged in alphabetical order. At the end of each definition, there may be references to other areas of the RGS book where additional or more specific information can be found. The use of this glossary may also make it easier to find the location of a term that is used within the RGS text material. Additional information can also be found on the NHPA website at www.horseshoepitching.com. **Note:** This glossary is intended as a quick reference only. Any final rulings or decisions should be based on the text information found in the Playing Rules, Requirements, Guidelines, or Specifications sections.

Altered Shoe – Refers to any shoe that has been changed from its original design. (See page 37, I – EQUIPMENT SPECIFICATIONS, Section B.)

Alternate Pitch – Alternate first pitch is a pitching rotation used to give each contestant an equal number of first and second pitches during a game. (See page 16, RULE 7, Section A.2)

Backstops/Backboards – Refers to the barriers installed at the far end of each pit for safety reasons. (See page 41, II – SPECIFICATIONS FOR COURT LAYOUT, Section B, 8.a; also see drawing on inside back cover)

Broken Shoe – Occasionally, a horseshoe may break into two or more parts when it hits other shoes, the stake, or lands in the pit. After the broken pieces are removed, another shoe may be pitched in its' place. (See page 17, RULE 9, Section A)

Burr – A small, displaced fragment of steel that may be created when a horseshoe hits other shoes or the stake. Burrs, if they go undetected, can cause moderately serious cuts to the fingers or hands and should be filed smooth before pitching the shoe.

Bylaws – *Roberts Rules of Order* defines Bylaws as a document adopted by an organization which contains the basic rules for governing itself. Bylaws define the primary objectives of an organization and describe how the organization will function.

Caliper – A measuring tool that can be adjusted to determine which shoe is closest to the stake.

Cancellation Scoring – A method of play, whereby opponents' ringers cancel each other. The same holds true for opponents' shoes (single points) that are of an equal distance from the stake. (See page 14, RULE 6, Section A.1)

Class – Refers to the group(s) of pitchers (usually 6-12 contestants/class) within a particular Division. (See page 20, RULE 11, Section E)

Class Winners – Class winners may be determined in several ways, depending on the tournament format. Usually the winner is determined by win/loss record. Ties may be broken by a playoff game, ringer percentage, total points scored, etc. (See page 18, Rule 11, Section B)

Count-all Scoring – A method of scoring where both contestants receive credit for all live shoes scored in each inning. (See page 14, RULE 6, Section A.2 and B.2)

Cracked Shoe – Occasionally, a horseshoe may develop a crack through normal use. If a shoe is discovered to be cracked during competition (but not completely broken in two) it shall be scored as it lies. Once the scoring is determined, it shall be replaced. (See page 18, RULE 9, Section B)

Crossover Areas – Refers to the areas in front of and/or behind the pits, where contestants may cross over to the opposite platform after the delivery of their shoes, if they've pitched first. (See page 11, RULE 3, Section E) Contestants may also “cross” over as they move toward the opposite end of the court, in anticipation of who may be pitching first in the next inning.

Dead Shoe – Another term for a foul shoe that was delivered in non-compliance with one of the rules of the game. This term may also refer to a ringer that has been “cancelled” by an opponent’s ringer. (See page 10, RULE 3, Section B, 1.b)

Division – There are currently five (5) Divisions recognized by the NHPA. They are: Juniors, Open Men, Open Women, Seniors, and Elders (this Division includes Physically Challenged Men). Some of these Divisions may not be contested at all tournaments. (See pages 7-8, RULE 1, Sections A-F)

Doubles Play – In doubles play, two contestants are partners against another team of two contestants. (See pages 28-29, GUIDELINE 1, Sections A and B)

Dress Code – For State Tournaments and the World Tournament, the dress code requires that your last name and State or Country abbreviation be professionally lettered on the back of your shirt(s), which cannot be sleeveless. Also, cut-offs and open-toed shoes may not be worn. (See page 21, RULE 12, Section C)

eShoe - Cloud based program that tracks membership and statistics for the National Horseshoe Pitchers Association.

Extended Platforms – A forward extension of the full-distance pitching platforms, toward the opposite pit, for an additional ten feet (10'), or for the entire distance between the opposite platforms, to accommodate short-distance pitchers. (See page 40, II SPECIFICATIONS FOR COURT LAYOUT, Section B.4, b.2; also see court diagram on inside back cover)

Feeler Gauge – A tool containing thin strips of metal of varying thicknesses. Used mainly by judges to determine measurements for the closest shoe and/or for determining if shoes are ringers.

Foul – (foot foul) This occurs when a pitcher steps on or over the foul line, or starts or steps completely outside of the pitching platform area, before the shoe is released. The penalty is to declare the shoe a foul shoe. (See pages 13, Rule 5, Section B, 1.a.b)

Foul Shoe – Another term for a “dead” shoe that was delivered in non-compliance with one of the playing rules of the game. (See pages 12-14, RULE 5)

Guidelines – Refers to a set of directions or chronological steps that have been successfully used by others and that are recommended in accomplishing a task or event. Good reason and logic are important parts of effective guidelines and the use of words such as “should”, “could”, or “may” provides for allowable variations.

Handicap – A handicap is a predetermined number of bonus points given to a player in addition to the actual “scratch” score pitched in a game. Handicapping may be used where there is a large “spread” of ringer percentages within a class. (See page 20, RULE 11, Section F; also the NHPA Sanctioned Club/League “Red” Book)

Handicapping – Handicapping may be used in leagues or tournaments where there is a larger difference in skill level, giving the less-skilled pitcher a better chance of winning or being more competitive. The amount of the handicap shall be determined by the Tournament/ League Officials. (See page 20, Rule 11, Section F)

Heel or Heel Calk – The area of the horseshoe (at the open end) that includes the “tips” and the “hooks”. (See diagram on inside front cover)

Hooks – Refers to a tool used, by some, to pick up horseshoes from the pit. May also refer to a portion of the heel calk, designed to secure ringers. (See page 37, I – EQUIPMENT SPECIFICATIONS, Section E)

Imaginary Stakes - Imaginary stakes shall be marked (often by a spot of paint or other marker of the same diameter as the official stake) midway between or next to the extended platforms, at distances of thirty feet (30) and twenty-three feet (23') from the opposite stakes. (See page 41, II – SPECIFICATIONS FOR COURT LAYOUT, Section B.5)

Inning – The game is divided into innings. In singles play, each inning consists of four (4) pitched shoes; two (2) by each contestant. (See page 10, RULE 3, Section A)

Judges – Judges are appointed by Tournament/League Officials to enforce the Playing Rules of the game, and to help resolve any questions that may arise during the event. (See page 34, GUIDELINE 4)

Leaner – A live shoe that comes to rest vertically while touching the stake. This shoe has a scoring value of one (1) point. (See page 10, RULE 3, Section B, 2.b)

Legal Shoe – Any official horseshoe that is sanctioned and approved by the NHPA. (See page 36, I – EQUIPMENT SPECIFICATIONS, Section A)

Live Shoe – Refers to any shoe that has been pitched in compliance with the rules of the game and that comes to rest within the pit area. (See page 10, RULE 3, Section B, 1.a)

Medical Exemption – Physically challenged male pitchers may be given permission by their governing Charter or NHPA officials to move onto the extended platforms and observe the twenty-seven-foot (27') foul lines before the age of seventy (70) years. The prior completion and approval of a Medical Exemption Form (available from Charter/State Secretaries) is required. (See page 9, RULE 1, Section F.2)

Mixed Classes – Mixed classes may include pitchers from any of the different Divisions such as Open Men, Open Women, Juniors, Elders, etc. (See pages 25, REQUIREMENT 3, Section A.2)

National Membership – An annual membership required for all pitchers participating in NHPA Sanctioned Leagues and/or Tournaments. (See page 23, REQUIREMENT 2, Section B)

Newsline – More officially, “Horseshoe Pitching Newsline” is the official online publication of the NHPA. (See Page 25, REQUIREMENT 3, Section B)

NHPA – Stands for National Horseshoe Pitchers Association; the official organization for the sport of horseshoe pitching. (See the NHPA website for additional information)

NHPF – Stands for the National Horseshoe Pitchers Foundation; the official spin-off organization of the NHPA, established to promote the game of horseshoes, and to provide and maintain the NHPA Hall of Fame facility. (See the NHPA website for additional information)

Pacer – Refers to an individual who may fill a vacated position during round-robin tournament play. (Also see page 16, RULE 7, Section D; and page 35, GUIDELINE 5)

Pit – A rectangular area around the stake, and between the platforms, that is filled with a pit substance into which the shoes are pitched. (See page 9, RULE 2, Section B, and page 39, II – SPECIFICATIONS FOR COURT LAYOUT, Section B, 4.a; also see diagram on inside back cover and page 49)

Pit Substance – The material into which horseshoes are pitched. Clay, sand, dirt, and approved synthetic compositions are all legal pit substances. (See page 42, II – SPECIFICATIONS FOR COURT LAYOUT, Section B.9)

Pitcher's Box – The six-foot (6') by six-foot (6') square area located at each end of the court. This area includes the pit, and pitching platforms. (See page 40, II – SPECIFICATIONS FOR COURT LAYOUT, Section B.4)

Pitching Platforms – The area from which contestants deliver their horseshoes. The full-distance pitching platforms flank the pits for the entire length of the pitcher's box. (See page 40, II – SPECIFICATIONS FOR COURT LAYOUT, Section B, 4.b)

Pitching Rotation – Refers to who will pitch first or second, for each inning of the game. (See pages 16, RULE 7)

Point Limit Game – Refers to a game that is played to a pre-determined number of points. (See page 17, RULE 8, Section A.1)

Point Limit or Shoe Limit Game – Refers to a game that is played to a pre-determined number of points or to a pre-determined number of shoes. For example, forty (40) points or fifty (50) shoes; whichever comes first. (See page 17, RULE 8, Section A.3)

Portable Pits – Also referred to as temporary or raised pits, they are usually made of treated plywood and framing lumber. These above-ground-level pits are often set up and used in arenas or other hard-surfaced areas for exhibitions, special tournaments, and/or special events. (See page 42, II – SPECIFICATIONS FOR COURT LAYOUT, Section C)

Protest – If a contestant does not agree with a ruling or decision, a protest shall be made to the judge or tournament official(s) at the time the problem occurs. If the problem cannot be resolved on the courts, the tournament director or committee shall make the final ruling on all protests. This ruling may occur after the game has been completed. (See page 21, RULE 12, Section F)

Requirements – Refers to required information, separate from the playing rules, that may apply to Sanctioned Tournaments, League Play, Charters/States, etc. and that does not have to do with the business of the NHPA.

Ringer – A ringer is a shoe that comes to rest while encircling the stake. A straightedge touching either the points or any part of the heel calks of the shoe must clear (not touch) the stake in order to be declared a ringer. A ringer has a value of three (3) points. (See page 10, RULE 3, Section B, 2.a)

Ringer Percentage – A pitcher’s ringer percentage (for a game, tournament, or eShoe) is determined by dividing the total number of ringers by the total number of shoes pitched. (See page 19, RULE 11, Section C)

“Ringers Only” Scoring – A variation of Count-all scoring where both contestants receive credit for only the ringers they have pitched in each inning. (See page 15, RULE 6, Section A, 2.b)

Round – Refers to any *one* of the games of a round-robin schedule. (See definition of Round-robin Schedule)

Round-robin Play – Refers to the standard method of NHPA sanctioned tournament play. In round-robin play, each contestant will play all other contestants in the Class. Court assignments and the order of play will follow a printed schedule, either posted or given to each contestant at the beginning of the contest. (See page 18, Rule 11, Section A)

Rules of Play – Or “playing rules”, refers to a set of prescribed directions or information for which a game, contest, or sporting event must follow. Failure to do so will result in one or more specified penalties. The words “shall”, “will”. or “must” are critical words to be expected in this text information.

Sanctioned Club/League Program – The NHPA Sanctioned Club/League Program introduces new and veteran horseshoe pitchers to League Play and provides instruction for an exciting, competitive, and healthful activity for all men and women; young, old, and/or physically challenged. (See the NHPA Sanctioned Club/League “Red Book” for additional information)

Sanctioned Court – A horseshoe court that meets the requirements for measurement, etc. as established by the NHPA. A Court Sanction Certificate may be issued by the Regional Director once these measurements and other requirements have been verified. (See page 38, II – SPECIFICATIONS FOR COURT LAYOUT, Section A. Also see diagram on inside back cover of the RGS Book).

Sanctioned Event – Any horseshoe pitching event which has been recognized and approved by the National Council and/or Charter Regional Directors and for which the results and records will be accepted, recorded, and published by the NHPA. This includes leagues, tournaments, and special events.

Sanctioned Tournament – The NHPA Tournament Sanction Certificate certifies that “THE OFFICIAL PLAYING RULES, REQUIREMENTS, GUIDELINES AND SPECIFICATIONS FOR THE SPORT OF HORSESHOE PITCHING (aka The RGS Book) will be followed and enforced, including the requirements of membership and use of sanctioned horseshoes. (See NHPA Regional Directors Guidelines)

Scorekeeping – The recording of scores is a very essential part of the game and the scorekeeper must be familiar with a variety of calls, how to record the score, etc. (See pages 33, GUIDELINE 3)

Scoring Area – Refers to the pit area within which a live shoe may come to rest and still score points. It can be thought of as the area which includes the one inch (1”) stake, plus the six inch (6”) “Shoe in Count” area surrounding the stake, plus an additional distance of approximately nine inches (9”) around the stake where a shoe *could* come to rest and still be a “Shoe in Count”. This scoring area becomes an approximate thirty-one inch (31”) diameter circle with the stake in the very center.

Scoring Radius – May be used in reference to the fifteen inch (15”) distance between the stake and the outside perimeter of the scoring

area. This area extends outward, in all directions, from the stake and includes the “Shoe in Count” area.

Scratch Play – Refers to a game where a handicap system is not used. (See page 24, REQUIREMENT 3, Section A.2, and NHPA Sanctioned Club/League “Red” Book)

Seeding – The placement of contestants, by the Tournament Director or Committee, into Classes for tournament play. For sanctioned events, this placement should be based on their current NatStats average ringer percentage. (See page 18, RULE 11, Section D)

Shoe in Count – Refers to any live shoe that is a ringer, or that may come to rest at a distance of six inches (6”) or closer to the stake. (See page 10, RULE 3, Section B, 2.a & b)

Shoe Limit Game – Refers to a game that is played to a pre-determined, even number of shoes. (See page 17, RULE 8, Section A.2)

Shoe Out of Count – Refers to any shoe that comes to rest further than six (6”) inches from the stake. (See page 10, RULE 3, Section B.3)

Single Point – Refers to any (non-ringer) live shoe that is six inches (6”) or closer to the stake. (See page 10, RULE 3, Section B, 2.b)

Specifications – Refers to a set of criteria that may include specific requirements, ranges, or allowances for time or distance, dimensions, or weights.

Sportsmanship-like Conduct – Refers to the expected and acceptable behavior of all pitchers while on or near the courts. (See page 21, Rule 12, Section B)

Stakes – The stake is the target at which the shoe is pitched. (See page 41, II – SPECIFICATIONS FOR COURT LAYOUT, Section B.6; also see diagrams on inside front cover and inside back cover)

Straightedge – Usually a metal bar tool that is straight along one or more edges, is about eight inches (8”) in length, and that is used in the measurement of ringers.

Temporary and/or Raised Pits – The regulations for temporary ground-level courts, with the exception that for any raised pit, the top of the pit shall be no more than seven (7) inches above the level of the pitching platforms. (See page 42, II – SPECIFICATIONS FOR COURT LAYOUT, Section C)

Time Limit – Contestants must deliver both shoes within thirty (30) seconds. (See page 11, RULE 3, Section C.2)

Toe – Refers to the area of the horseshoe that is farthest from the open end. (also see diagram on inside front cover)

Welded Shoe – Broken or cracked horseshoes are sometimes welded as a means of repair for continued use. Welding, and other repairs to horseshoes, is legal if the shoe is not altered in the process, and so long as the shoe still meets all of the measurement requirements for NHPA sanctioned horseshoes.

(See page 37, I – EQUIPMENT SPECIFICATIONS, Section C)

Anatomy of a pitching shoe

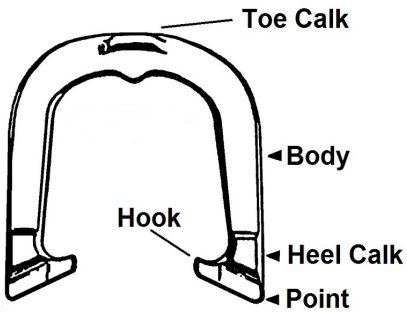

Stake Detail

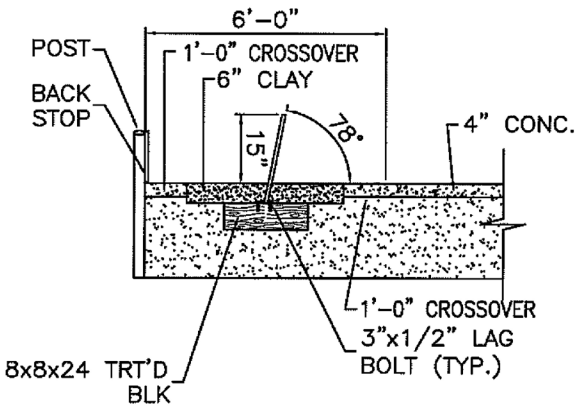

NOTES:

1. THE "PITCHERS BOX" IS THE 6'X 6' AREA AT EACH END OF THE COURT.
2. THE RECOMMENDED PIT SIZE IS 36"X 48".
3. A MINIMUM OF 4" THICK REINFORCED CONCRETE IS RECOMMENDED FOR PAVED SURFACES.

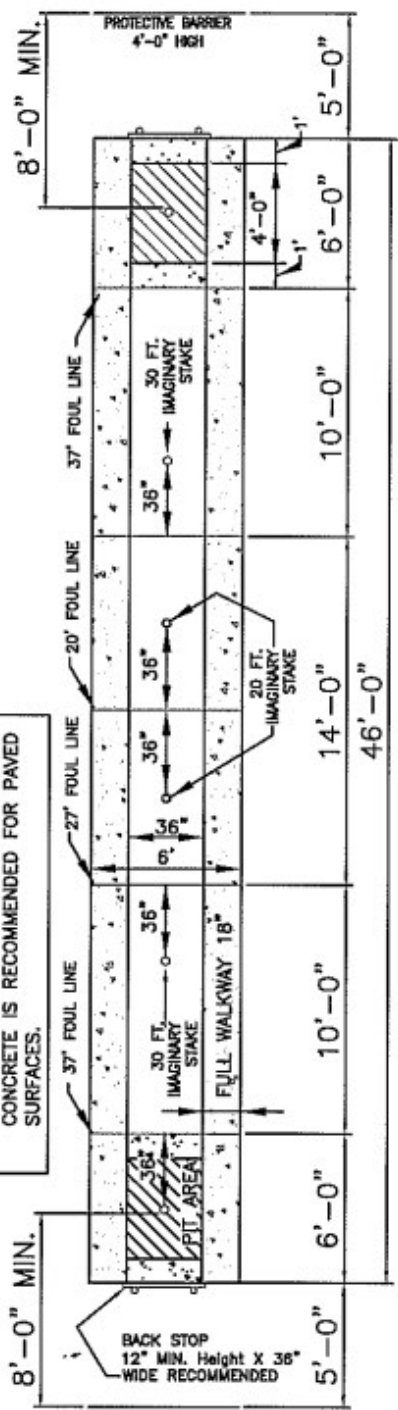

**HORSESHOE COURT
LAYOUT**